



**Instructions for building the
fireplace enclosure by
SKAMOTEC 225 isolation
plates.**

Materials needed to building fireplace enclousre by SKAMOTEC 225:



SKAMOTEC 225 PLATES



SKAMOTEC HT PRIMER



SKAMOTEC HT ADHESIVE



SKAMOTEC TD SCREWS



SKAMOTEC PRIMER



SKAMOTEC ADHESIVE



SKAMOTEC MESH

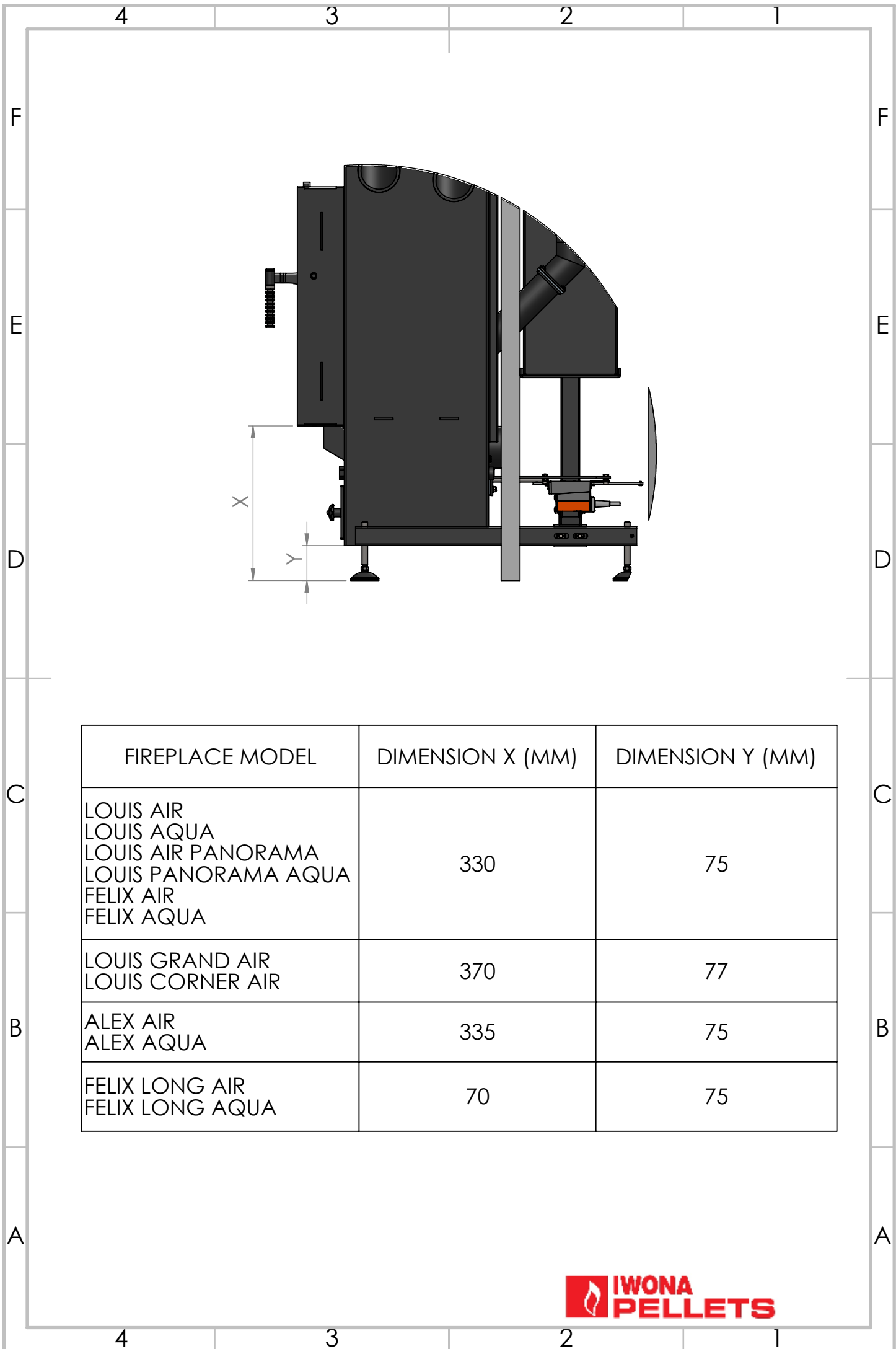

FIREPLACE MODEL	DIMENSION X (MM)	DIMENSION Y (MM)
LOUIS AIR LOUIS AQUA LOUIS AIR PANORAMA LOUIS PANORAMA AQUA FELIX AIR FELIX AQUA	330	75
LOUIS GRAND AIR LOUIS CORNER AIR	370	77
ALEX AIR ALEX AQUA	335	75
FELIX LONG AIR FELIX LONG AQUA	70	75

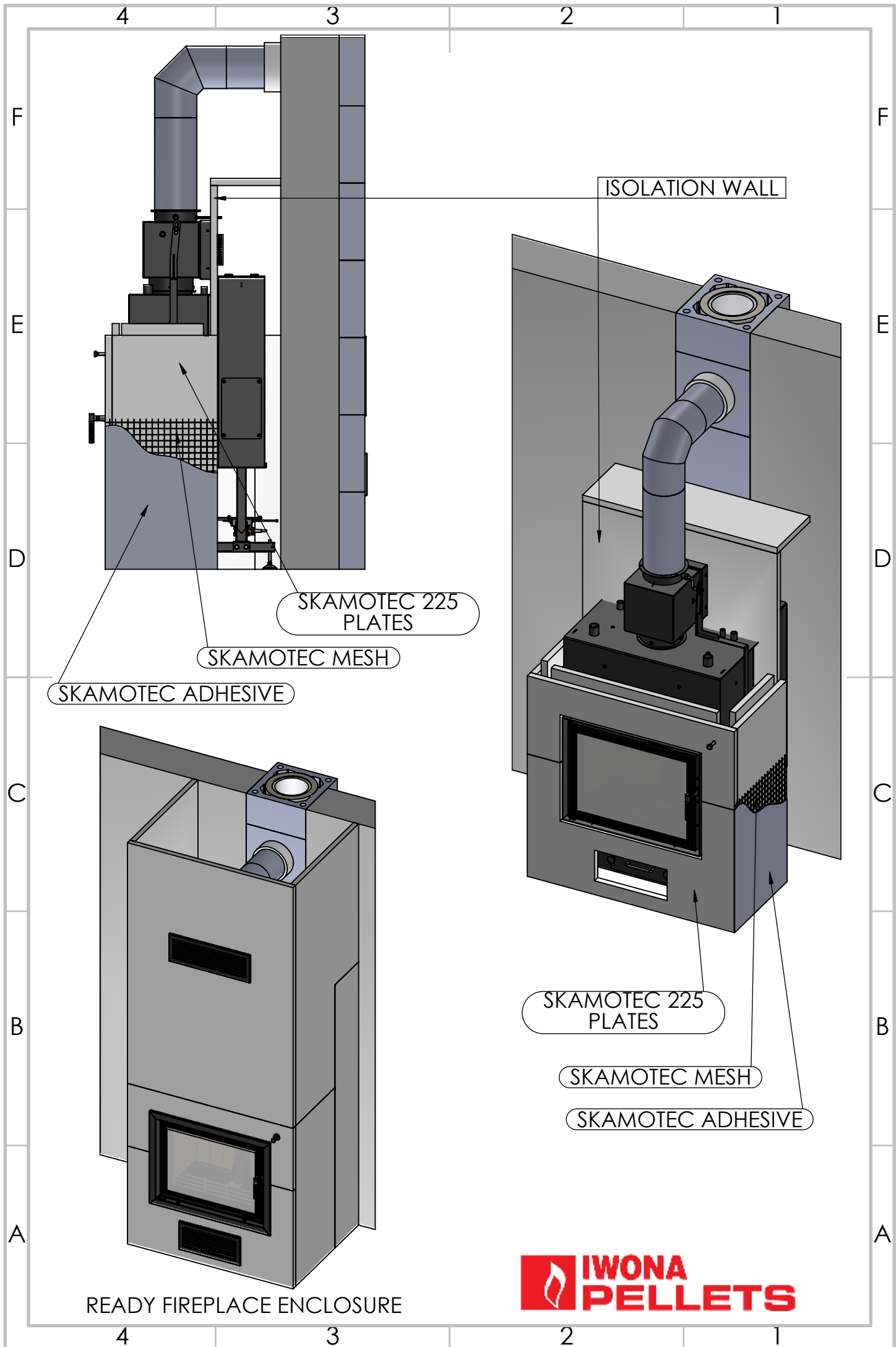

UPPER GRATE

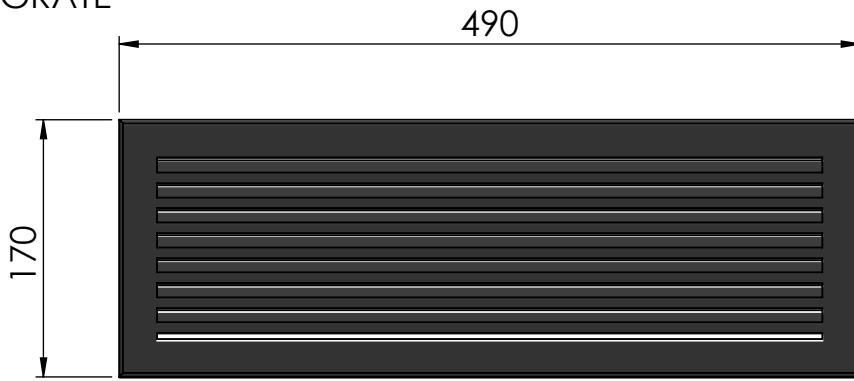

DOWN GRATE

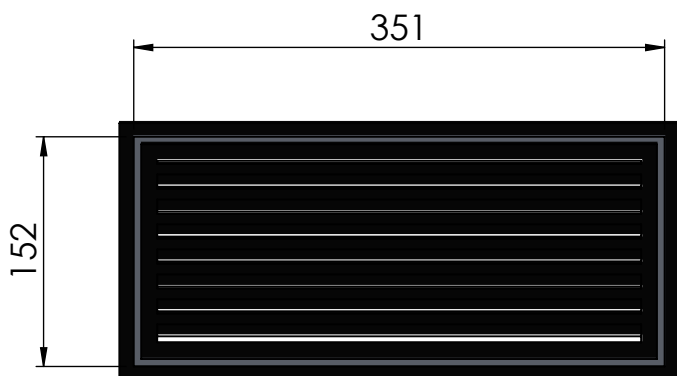
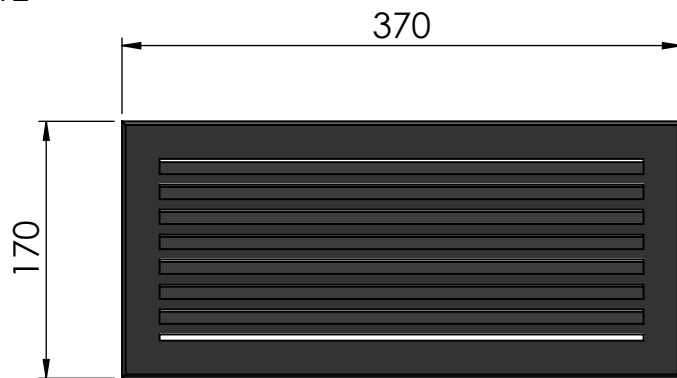

TITLE:

MINIMUM DIMENSION OF GRATS FOR
FIREPLACE ENCLOSURE



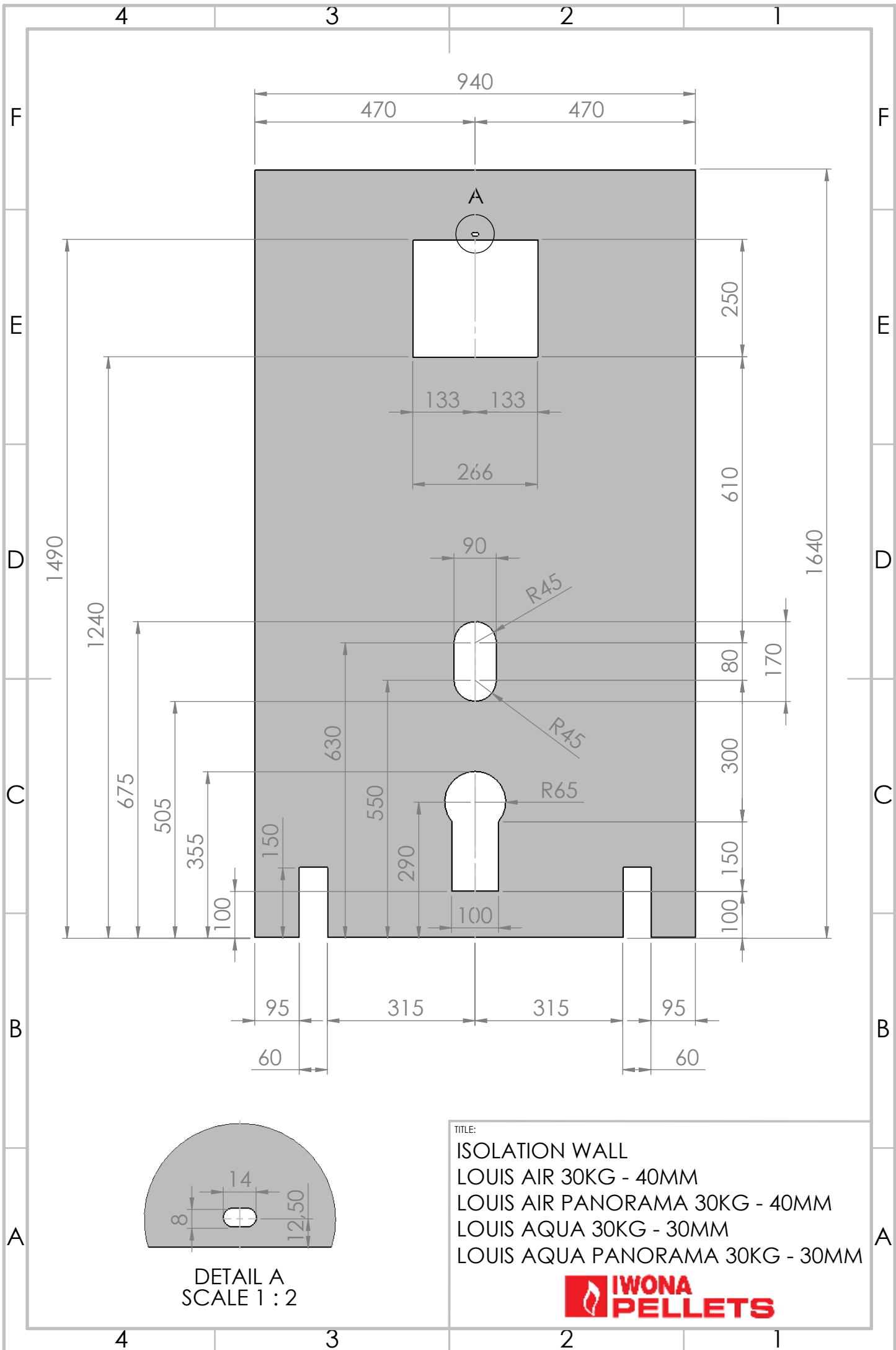

TITLE:

- ISOLATION WALL
- LOUIS AIR 30KG - 40MM
- LOUIS AIR PANORAMA 30KG - 40MM
- LOUIS AQUA 30KG - 30MM
- LOUIS AQUA PANORAMA 30KG - 30MM



DETAIL A
SCALE 1 : 2

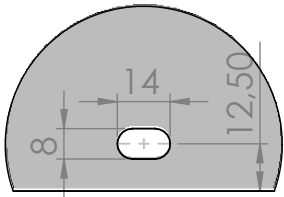
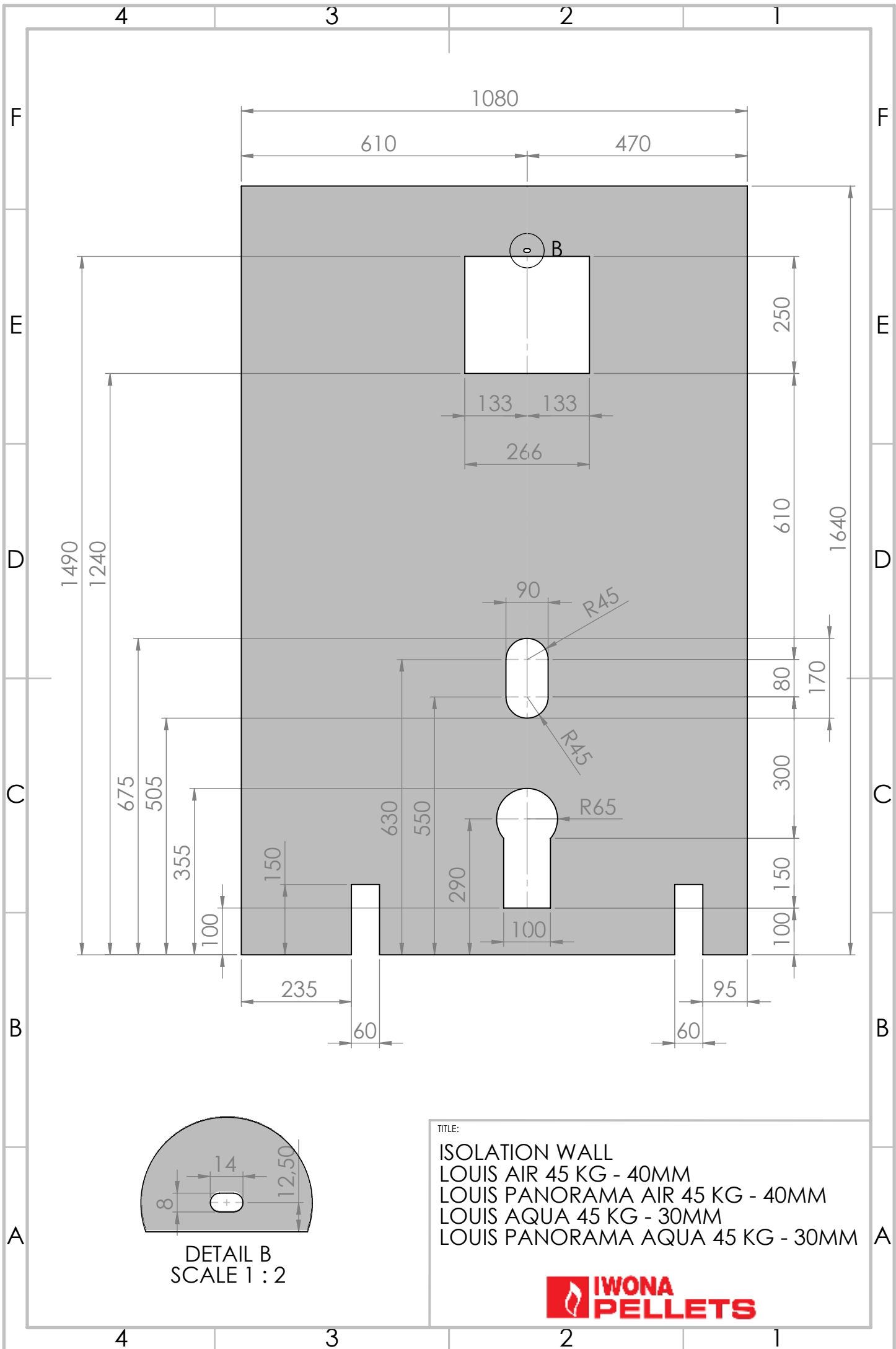

DETAIL B
SCALE 1 : 2

TITLE:

- ISOLATION WALL
- LOUIS AIR 45 KG - 40MM
- LOUIS PANORAMA AIR 45 KG - 40MM
- LOUIS AQUA 45 KG - 30MM
- LOUIS PANORAMA AQUA 45 KG - 30MM



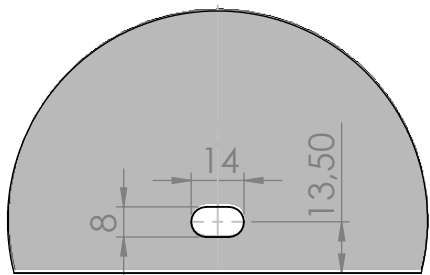
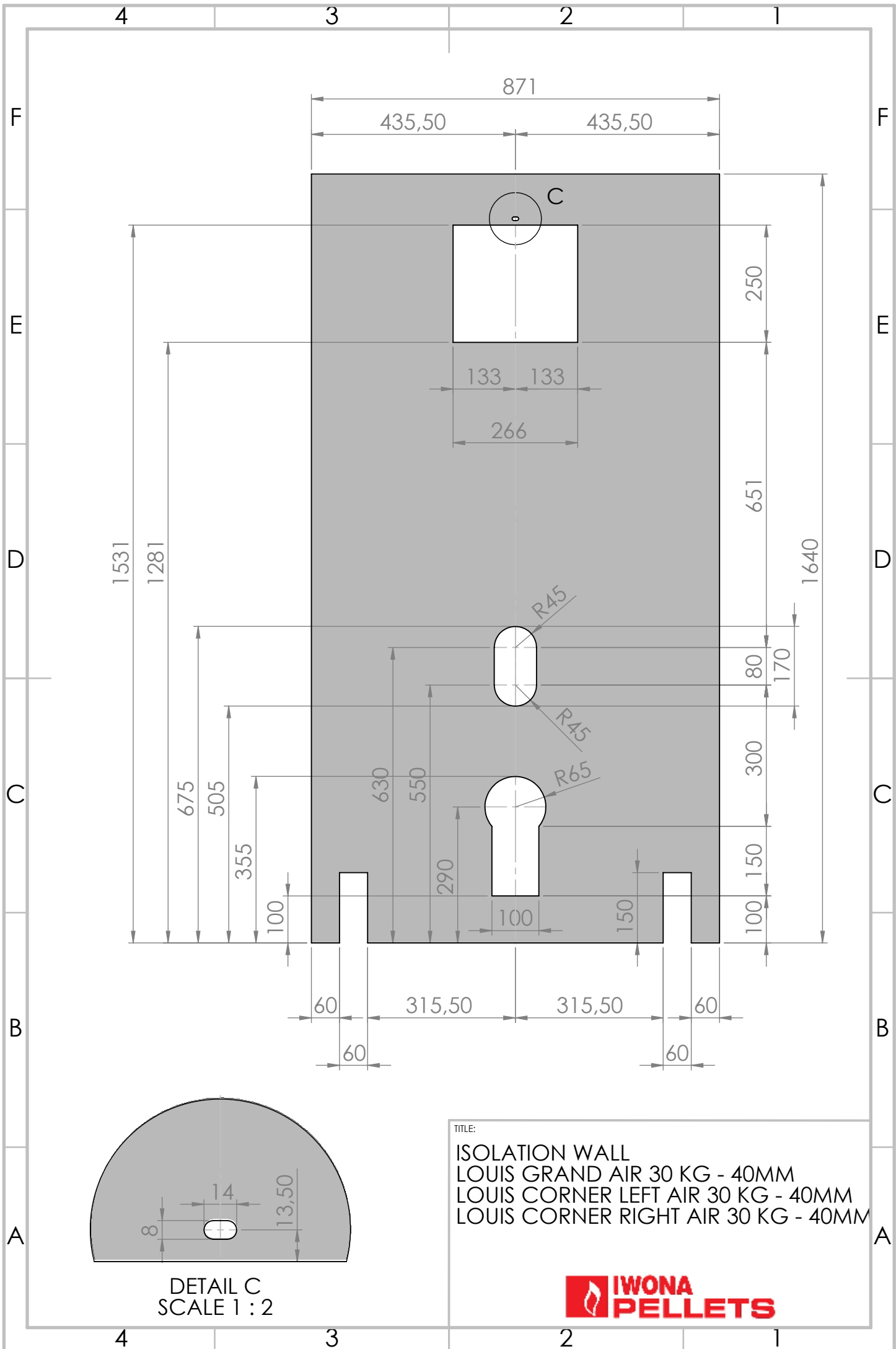

TITLE:
 ISOLATION WALL
 LOUIS GRAND AIR 30 KG - 40MM
 LOUIS CORNER LEFT AIR 30 KG - 40MM
 LOUIS CORNER RIGHT AIR 30 KG - 40MM



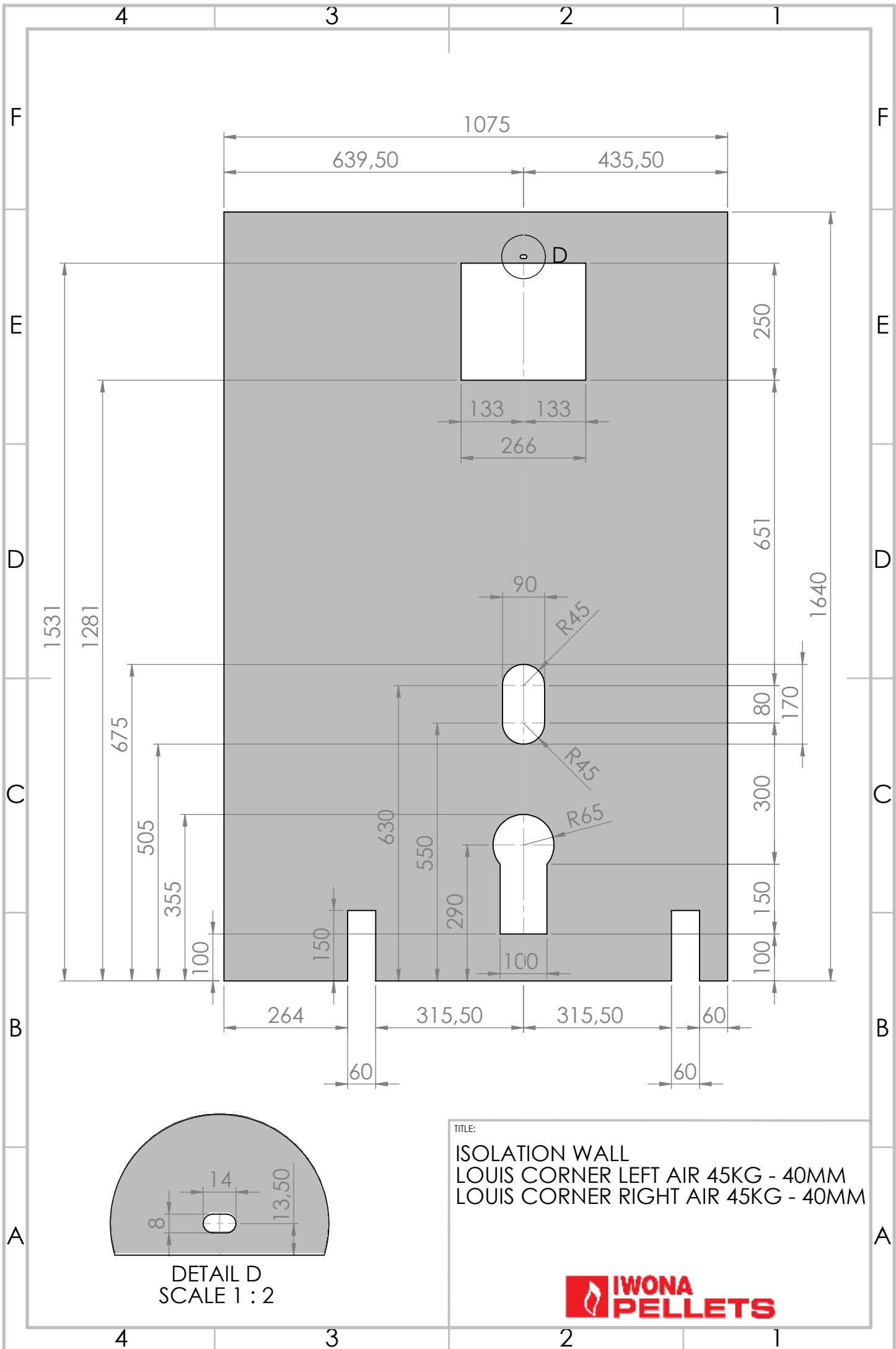

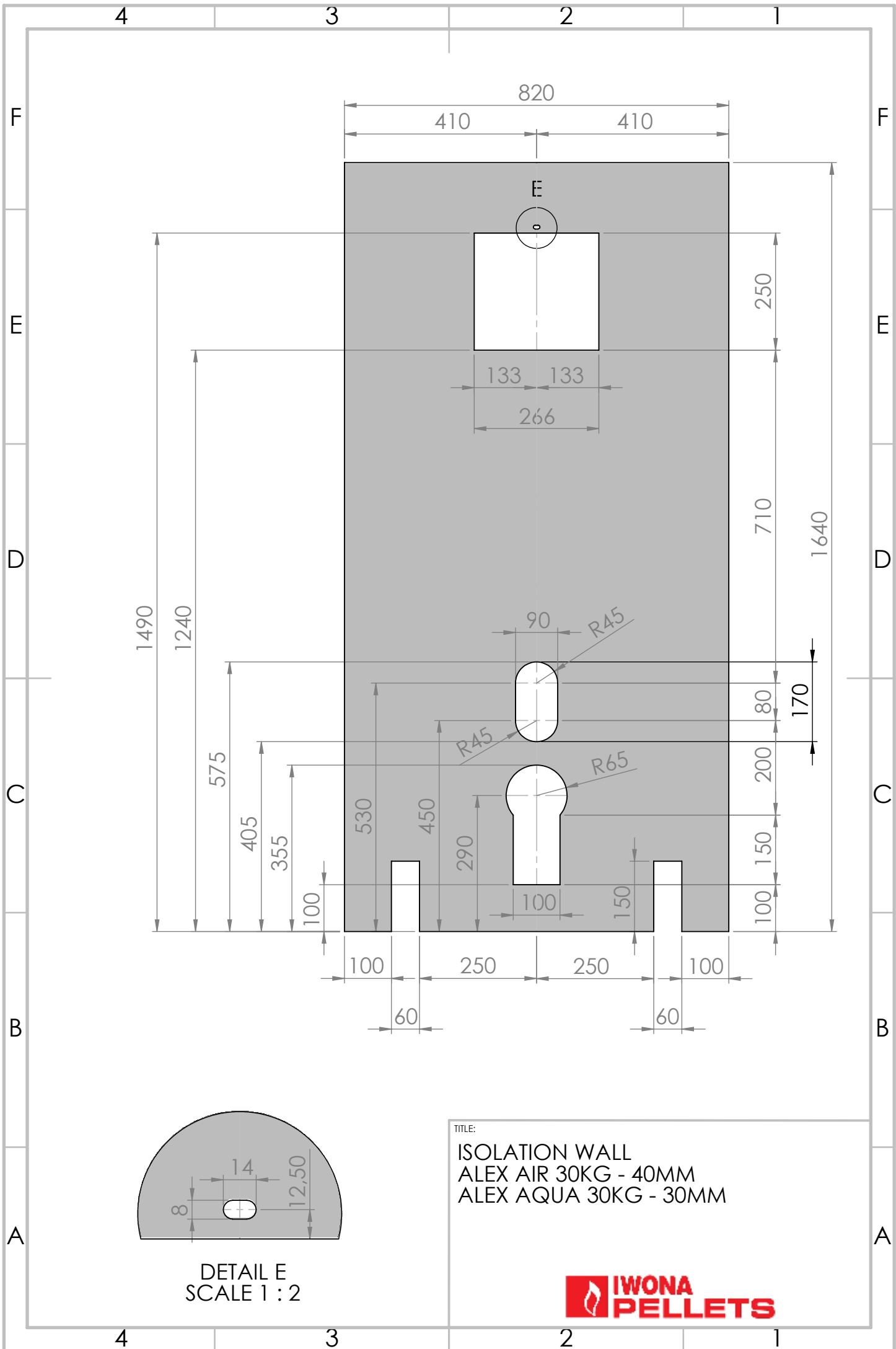

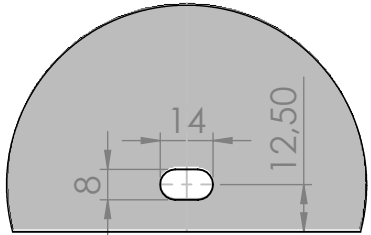
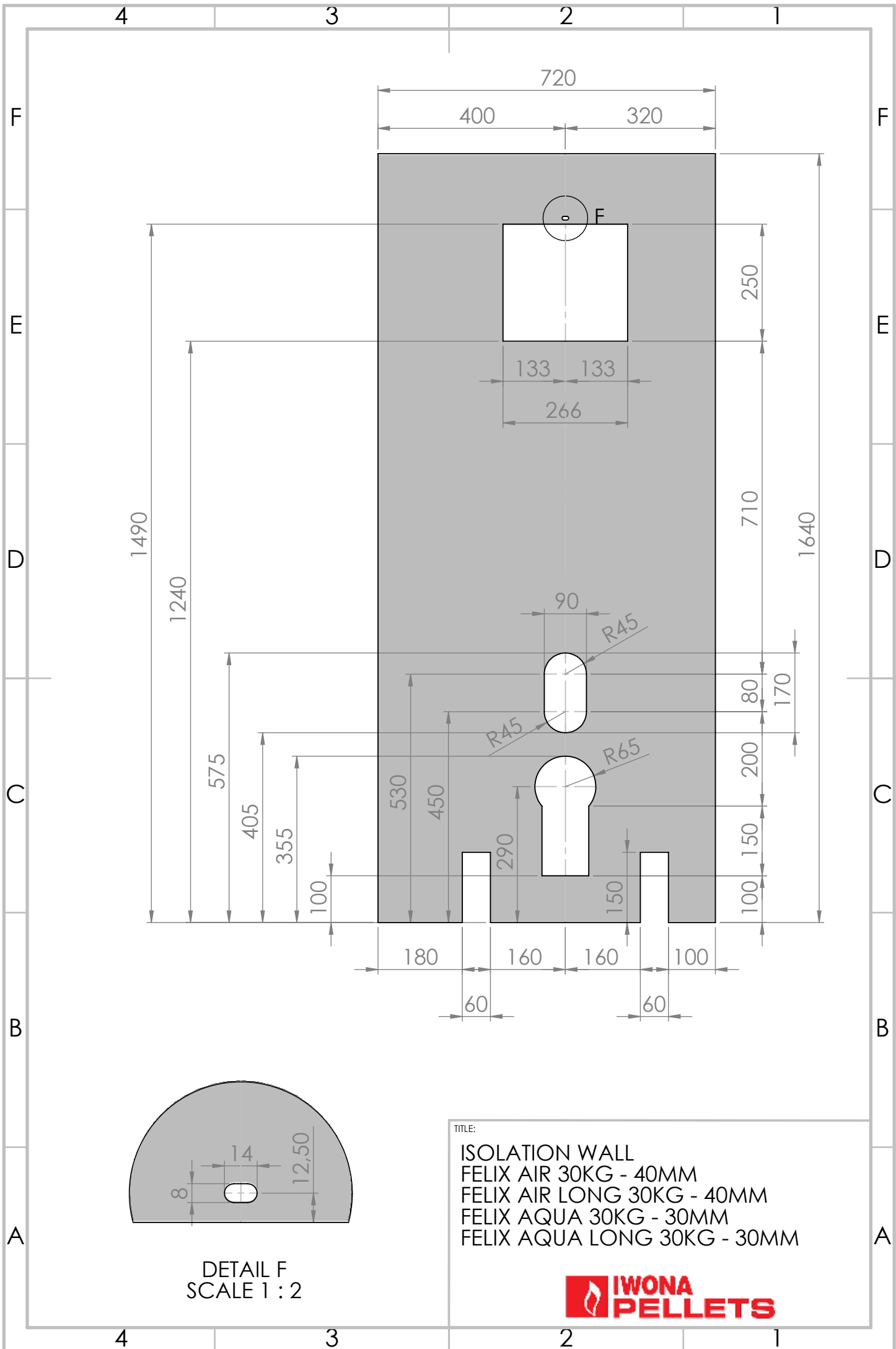

TITLE:

ISOLATION WALL
 FELIX AIR 30KG - 40MM
 FELIX AIR LONG 30KG - 40MM
 FELIX AQUA 30KG - 30MM
 FELIX AQUA LONG 30KG - 30MM



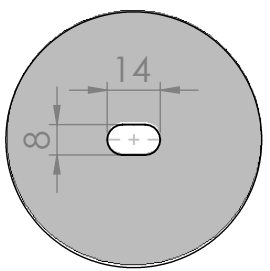
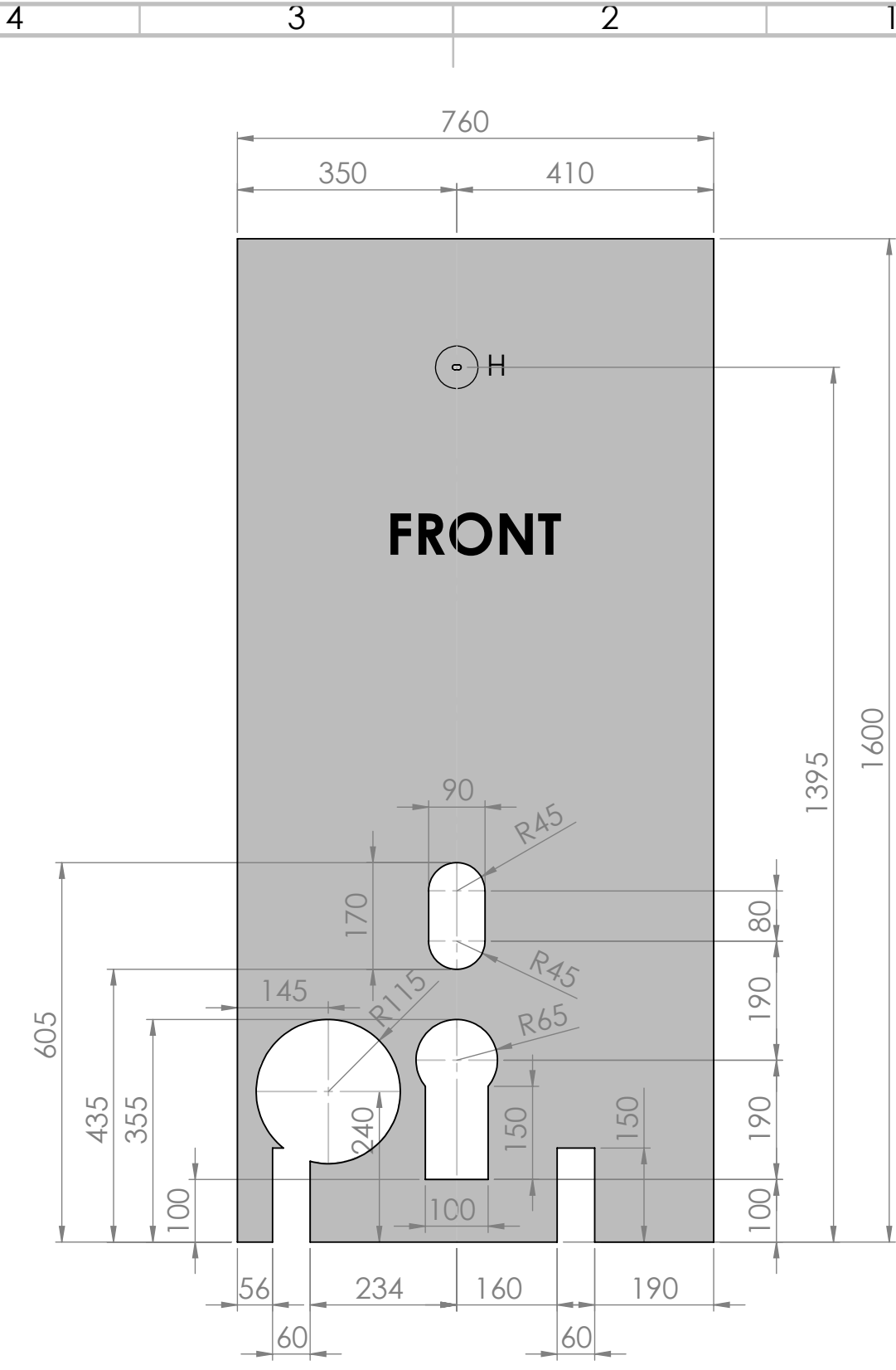

TITLE:
ISOLATION WALL
FELIX AIR V2 30KG - RIGHT TANK - 40MM



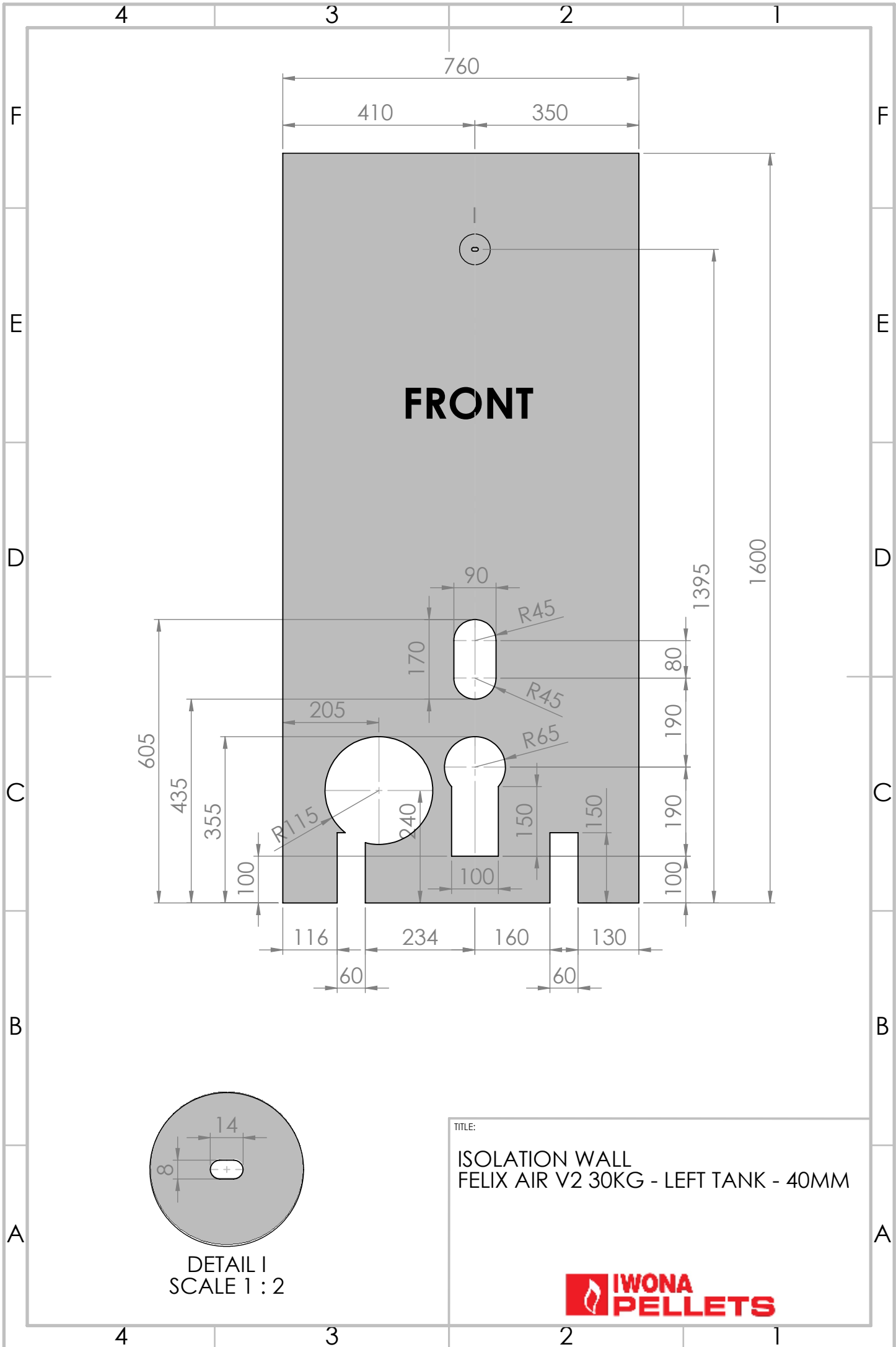

FRONT

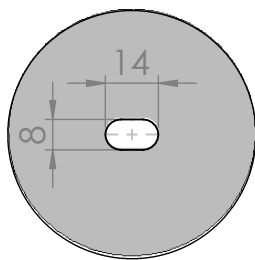
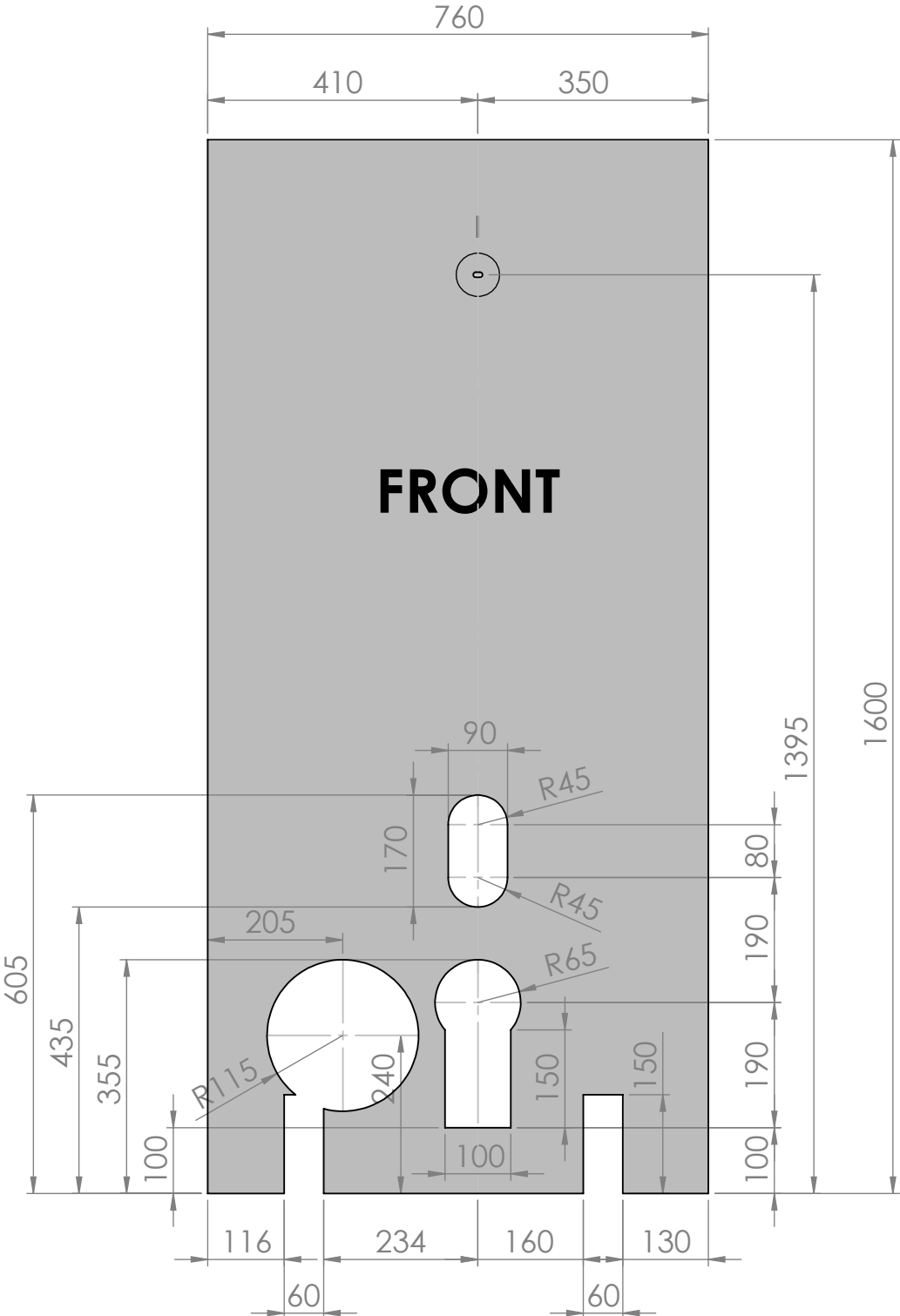

DETAIL I
SCALE 1 : 2

TITLE:
ISOLATION WALL
FELIX AIR V2 30KG - LEFT TANK - 40MM

